

# Roger™ BaseStation

User Guide



roger



PHONAK

---

# Contents

1	Welcome	4
2	System description	5
2.1	Roger for Studio system	5
3	Getting to know your Roger BaseStation	6
3.1	In the box	6
3.2	Roger BaseStation front panel view	7
3.3	Roger BaseStation rear panel view	7
3.4	Indicator light (LED status)	8
3.5	Transmission range	8
4	How to install Roger BaseStation	10
4.1	Single rack kit mounting	10
4.2	Wall mount	11
4.3	Dual rack kit mounting	12
4.4	Power supply	13
4.5	Security slot	14
5	Getting started	15
5.1	Connecting power supply	15
5.2	Connecting audio source	15
5.3	Switching on and off	16
5.4	Pairing Roger BaseStation with a Roger Earpiece	17

---

5.5	Pairing Roger BaseStation with a Roger Touchscreen Mic	18
5.6	Roger BaseStation range	20
6	Using Roger BaseStation	21
6.1	Input signal monitoring	22
6.2	How to adjust Roger Earpiece volume	22
6.3	NewNet	23
7	Troubleshooting	24
8	Performance	27
9	Standard applied	28
10	Important information	29
10.1	Hazard warnings	29
10.2	Product safety information	30
10.3	Other important information	31
10.4	Declaration of Conformity	32
11	Service and warranty	35
11.1	Local warranty	35
11.2	International warranty	35
11.3	Warranty limitation	35
12	Information and explanation of symbols	37
13	Homologation references	38

---

# 1 Welcome

Congratulations on choosing the Roger BaseStation from Phonak Communications AG. Used with the Roger Earpiece, this compact transmitter uses adaptive wireless transmission to allow people to receive audio information discreetly. The Roger for Studio system delivers the features and performance demanded by professionals. Your Roger BaseStation is a premium-quality Swiss product developed by Phonak Communications AG, part of Sonova AG, the world's leading hearing healthcare company.

---

## 2 System description

### 2.1 Roger Earpiece communication system

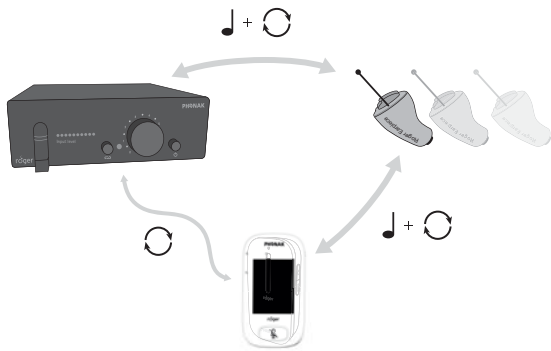

# 3 Getting to know your Roger BaseStation

## 3.1 Box contents



Roger BaseStation

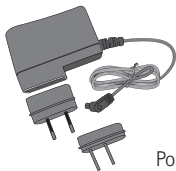

Power supply



Standalone feet

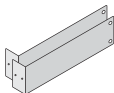

Single Rack Mount kit



Hex key



Rack mounting  
M6 Screws



Rack mounting  
M8 Screws



Cardboard stencil for  
wall-mounting



Torx key



Plastic anchor and screws  
for wall-mounting



User guide

## 3.2 Roger BaseStation front panel view

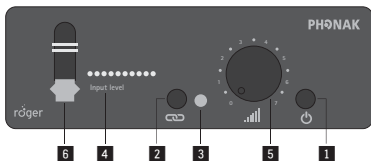

- 1 On/Off button
- 2 Connect button
- 3 Connect LED
- 4 Audio input graphical display
- 5 Volume control
- 6 Antenna

## 3.3 Roger BaseStation rear panel view

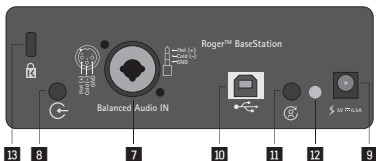







- 7 XLR & 6.3 (1/4") socket
- 8 3.5 socket
- 9 Power supply socket
- 10 USB-B (only for service)
- 11 NewNet button
- 12 NewNet LED
- 13 Security lock

### Note:

For unbalanced input, both mono and stereo plugs can be used. When using stereo plugs, the stereo signal will be transformed into a mono signal.

### 3.4 Indicator light (LED status)

LED	Status	Means
Power		Off / Aus / Eteint
		On / Ein / Enclenché
Connect		Roger Earpiece connected Roger Earpiece verbunden Roger Earpiece connectée
		No Roger Earpiece in range Keine Roger Earpiece in Reichweite Pas de Roger Earpiece à portée
		Not a compatible receiver Empfänger nicht kompatibel Le récepteur n'est pas compatible
Newnet		Network resetted Neues Netzwerk erstellt Le réseau a été réinitialisé



---

### 3.5 Transmission range

The Roger BaseStation should ideally be placed in the center of the area to be covered. Walls, metallic elements and human bodies are obstacles, which might reduce the transmission range.

**Warning:**

**Do not turn, unscrew or replace antenna.**

---

## 4 How to install Roger BaseStation

Roger BaseStation can be used standalone, mounted in a rack, or mounted on a wall by using the accessories included in the device packaging.

### 4.1 Single rack kit mounting

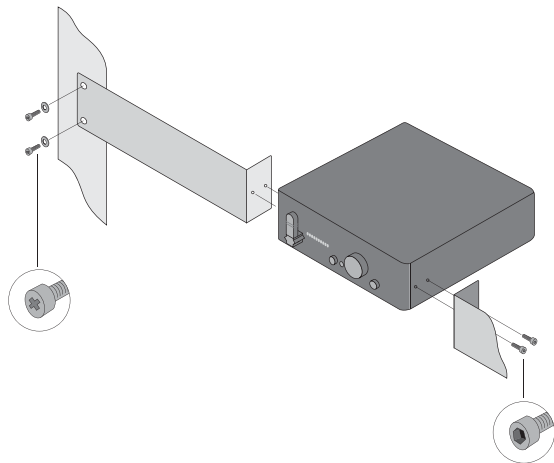

## 4.2 Wall mount

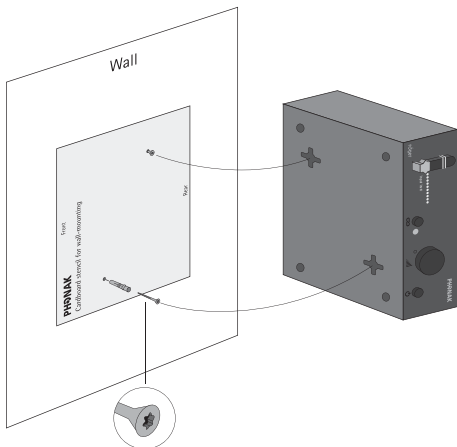

### Note:

- The Roger BaseStation must be mounted so that the antenna is on the upper side of the box.
- Do not turn the antenna: the Roger BaseStation offers the best performance when the antenna is oriented as on the drawing.
- Do not unscrew the antenna.
- Do not replace the antenna.

---

## 4.3 Dual rack kit mounting

To mount two Roger BaseStations in the same rack slot, please order the 19" installation kit for two Roger BaseStations separately.

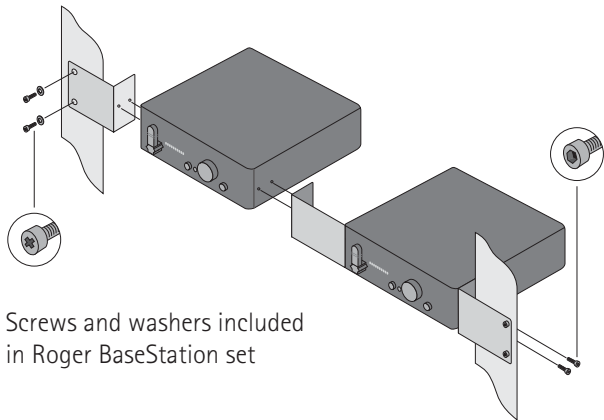

Screws and washers included  
in Roger BaseStation set

---

## 4.4 Power supply

- 1) Insert the plug adapter corresponding to the right country in the universal power supply:



Note: the packaging contains EU and US plugs. Other plug adapters are available as spare parts. For more information, please contact your local Phonak representative.

- 2) Connect the power supply to an electrical outlet, and then connect the power cable to the power supply socket located on the rear panel of the Roger BaseStation.

**Power supply**    100–240 VAC to 5.3 VDC / 4 A

---

## 4.5 Security slot

The Roger BaseStation includes a security slot on the back panel to secure your device from theft. The slot complies with the K & Lock® standard.

---

## 5 Getting started

### 5.1 Connecting the power supply

Connect the power supply to an electrical outlet, and then connect the power cable to the power supply socket located on the rear panel of the Roger BaseStation.

### 5.2 Connecting an audio source

The Roger BaseStation has two audio input options: a balanced connection (XLR or Jack 6.3) and an unbalanced connection (Jack 3.5). Use the balanced input if you have a balanced connection such as from a professional audio mixer. Use the unbalanced input to connect to an unbalanced audio source such as from a portable audio source (mobile phone, laptop or MP3 player).

If both unbalanced and balanced plugs are connected, the unbalanced input has priority. In that case the audio signal from the XLR/Jack 6.3 will not be transmitted.

---

## Balanced

XLR socket front view

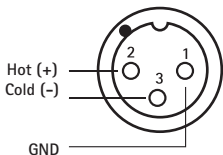

Jack 6.3 (1/4")

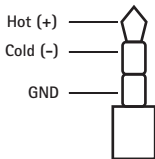

## Unbalanced

The unbalanced 3.5 jack connection supports mono or stereo connections. When using stereo plugs, the stereo signal will be transformed into a mono signal.

### 5.3 Switching on and off

To turn the Roger BaseStation on or off, press the button on the front panel.



---

## 5.4 Pairing Roger BaseStation with a Roger Earpiece

To connect a Roger Earpiece to the BaseStation for the first time, hold it within 10 cm / 4 inches of the Roger BaseStation and briefly press the Connect button on the front panel.

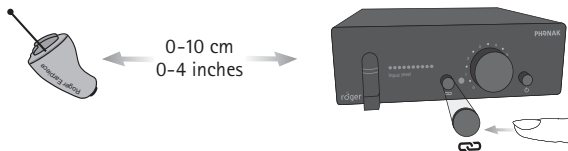

- Only one Roger Earpiece can be Connected at a time. Keep any other Roger devices out of range during this process.
- An unlimited number of Roger Earpieces can be connected.
- Connecting a Roger Earpiece is only required the first time it is used. The Roger Earpiece will then remain connected with the Roger BaseStation as long as the NewNet function has not been activated (pt 6.3).
- Refer to the Indicator light section for the different meaning of the LED indicator.

---

## 5.5 Pairing Roger BaseStation with a Roger Touchscreen Mic

To connect a Roger Touchscreen Mic, hold it within 10 cm / 4 inches of the Roger BaseStation.

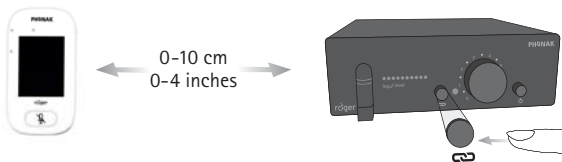

- To connect the Roger Touchscreen Mic to a Roger BaseStation, press either:
  - 1) Connect on the Roger BaseStation, or
  - 2) JoinNet on the Roger Touchscreen Mic (this can be done near to the Roger BaseStation or near to a Roger Earpiece)
- Only one Roger Touchscreen Mic can be paired at a time. Keep any other Roger devices out of range during this process. It's not possible to connect multiple Roger BaseStation transmitters together.
- The number of connected Roger Touchscreen Mics is limited to 35.

- 
- Connecting the Roger Touchscreen Mic is only required the first time. The Roger Touchscreen Mic will then remain connected with the Roger BaseStation as long as the NewNet function has not been activated (pt 6.3).
  - The Connect LED on Roger BaseStation will show green for two seconds to confirm a successful connection. If the connection was not successful, the light will blink red twice. For further information on the LED indicator, please refer to the Indicator light section (pt 3.4).
  - Only one audio signal (Roger BaseStation or e.g Roger Touchscreen Mic) can be heard at a time. When two audio signals arrive simultaneously, the audio signal from the Roger BaseStation always has priority.
  - As the Roger BaseStation is master of the network, if the Roger BaseStation is turned off or a Roger Touchscreen Mic moves out of range, the Roger Touchscreen Mic will stop transmitting and its light will blink. For more information, please refer to the Roger Touchscreen Mic user-guide.

---

## 5.6 Roger BaseStation range

The typical coverage range is 15–40 meters (49–131 ft), depending on environment. Note that human bodies and obstacles may reduce this distance.

### **Warning:**

**Do not turn, unscrew or replace the antenna. The Roger BaseStation has been tested to comply with EMC standards with the antenna provided. Replacing or altering the antenna would void this compliance.**

---

## 6 Using Roger BaseStation

### 6.1 Input signal monitoring

The input signal meter indicates the strength of the audio input signal. With an appropriate audio signal level, the red LEDs should never light up. To increase or decrease the signal, adjust the gain on the audio source directly.

#### Range unbalanced input (jack 3.5)

Nominal        -27 dBu / 0.035 VRMS

Max             0 dBu / 0.77 VRMS

#### Range balanced input (XLR + jack 6.3)

Nominal        0 dBu / 0.77 VRMS

Max             +20 dBu / 7.75 VRMS



Too weak



Adequate



Too strong

---

## 6.2 How to adjust the Roger Earpiece volume



To adjust the output volume of all Roger Earpieces in range of a Roger BaseStation, turn the volume control knob on the Roger BaseStation front panel. To increase the volume, turn the rotary knob clockwise.

- The Roger Earpiece output volume can be set in a range from -14 dB to +12 dB, in steps of 2dB.
- To mute the Roger Earpiece volume, turn the rotary knob to the left until the '0' mark.
- A change in volume effects all connected Roger Earpieces in range. Note that a Roger Earpiece joining the network after adjusting the volume control will experience the same volume as other connected devices. The volume of an individual Roger Earpiece can be adjusted using a Roger Touchscreen Mic. For more information, please refer to the Roger Touchscreen Mic user guide.

---

## 6.3 NewNet

To disconnect the Roger BaseStation from any connected Roger devices, press and hold the NewNet button located on the rear panel of the Roger BaseStation for more than 7 seconds. The LED next to the NewNet button will show green for 2 seconds when the network reset is complete and all devices have been disconnected.

---

## 7 Troubleshooting

---

---

### **I cannot switch the Roger BaseStation on**

---

The power cable is not connected, either to the Roger BaseStation back panel, or to an electrical outlet

---

---

### **Solutions**

---

Check the power supply's connections

---

---

### **The input level meter does not show any activity**

---

The Roger BaseStation is off  
There's no audio source connected

---

---

### **Solutions**

---

Turn the Roger BaseStation on  
Check the connections on the Roger BaseStation rear panel

---

The audio input source level is too low

---

Increase the audio source volume until all green LEDs are blinking

---

---

### **Red LEDs on the input level meter are blinking**

---

The source volume is too high

---

---

### **Solutions**

---

Decrease the source volume

---



---

**The signal is not transmitted even if the device is switched on and all connections are right**

---

The signal is on the balanced input, but there's also a plug in the unbalanced socket.

---

The Roger Earpiece is not connected to the Roger BaseStation

---

The transmitted audio is muted

---

In a network with a Roger Touchscreen Mic, the Roger BaseStation may not be switched on or may be out of range

---

---

## Solutions

---

Disconnect the unbalanced audio source. Unbalanced audio signal has priority over the balanced input.

---

Hold Roger Earpiece close to the Roger BaseStation and press the Connect button

---

Turn the volume control rotary knob clockwise to unmute the transmitter

---

Turn the Roger BaseStation on, or move the Roger Touchscreen Mic closer to the Roger BaseStation

---

---

**The transmitted audio signal is interrupted**

---

The distance between the Roger Earpiece and Roger BaseStation is too large

---

There are obstacles between you and the Roger BaseStation

---

---

**Solutions**

---

Move closer to Roger BaseStation or change orientation (avoid body absorption)

---

Make sure you can see the Roger BaseStation (line of sight)

---

---

**Roger Earpiece is receiving the wrong audio source**

---

The Roger Earpiece is connected to the wrong Roger BaseStation.

---

---

**Solutions**

---

Set up a new network by pressing the NewNet button on the rear panel of the Roger BaseStation and connect the Roger Earpiece to the correct Roger BaseStation.

---

---

## 8 Performance

Frequency range	2.402 GHz up to 2.480 GHz
Power emission	100 mW
Audio bandwidth	100 Hz - 7200 Hz
Distortion	-42 dB (< 0.8 % @ 1 kHz)
Signal to Noise Ratio	55 dB (@ 1 kHz)
Housing Dimensions (L x W x H)	132 x 132 x 44 mm (5.1" x 5.1" x 1.6")
Weight	488 g (1.1 lbs)
Operating range	15 - 40 m (49-131 ft)
Power consumption	225 mW (75 mA @ 3 V)
Operating conditions	0° to + 45° Celsius (+32° to +113° Fahrenheit) and relative humidity of <95% (non-condensing)
Transport and storage conditions	-20° to +60° Celsius (-4° to +140° Fahrenheit) and relative humidity of 90% for a long period

---

## 9 Standards applied

---

**Electrical safety:**

---

---

IEC/ EN 60950-1

---

---

**Radiocom 2.4 GHz:**

---

---

EN 300 328

---

---

**EMC:**

---

---

EN 301.489-1,-3,-9,-17

---

---

**FCC:**

---

---

Part 15C

---

---

**IC:**

---

---







RSS-247

---

---

# 10 Important information

## 10.1 Hazard warnings

-  Keep this device out of reach of children aged under 3 years.
-  Opening the device might damage it. If problems occur that cannot be resolved by following the guidelines in the Troubleshooting section of the User Guide, consult your local Phonak Communications AG representative.
-  Your device should only be repaired by an authorized service center. Changes or modifications to this device that were not explicitly approved by Phonak Communications AG are not permitted.
-  Please dispose of electrical components in accordance with your local regulations.
-  Do not use your device in areas where electronic equipment is prohibited. If in doubt, please ask the person in charge.
-  Device should not be used on aircraft unless specifically permitted by flight personnel.
-  Only use accessories that are approved by Phonak Communications AG.

- 
- ⚠ Using your device's cables in any way contradictory to their intended purpose (e.g., wearing the USB cable around the neck) can cause injury.
  - ⚠ Caution: electric shock. Do not insert plug alone into electrical outlets.

## 10.2 Product safety information

- i Protect the device from excessive shock and vibration.
- i Protect the device from excessive moisture (bathing, swimming).
- i Do not expose your device to temperatures and humidity outside of the recommended conditions stated in this User Guide.
- i Never use a microwave or other heating devices to dry the device.
- i Clean the device using a damp cloth. Never use household cleaning products (washing powder, soap, etc.) or alcohol to clean the device.
- i Only supply your device using adapters supplied by Phonak Communications.
- i When the device is not in use, turn it OFF and store it safely.

- 
- ① X-ray radiation, CT or MRI scans may destroy or adversely affect the correct functioning of the device.
  - ① Do not use excessive force when connecting your device to its different cables.
  - ① Protect all openings (audio input and charge) from dirt and debris.
  - ① If the device has been dropped or damaged, if it overheats, has a damaged cord or plug, or has been dropped into liquid, stop using your device and contact your authorized service centre.

### 10.3 Other important information

- Device collects and stores internal technical data. This data may be read by an authorized service center in order to check the device, as well as to help you use your device correctly.
- The digital signal sent from the device to a connected receiver cannot be overheard by other devices which are not in the transmitter's network.

---

## 10.4 Declaration of Conformity

In body worn operation, the devices have been found in compliance with the requirements of EN 62209-2, FCC rule paragraph 2.1093, the ANSI/IEEE C95.1:1999, the NCRP Report Number 86 for uncontrolled environment, according to the Health Canada's Safety Code 6 and the Industry Canada Radio Standards Specification RSS-102 for General Population/Uncontrolled exposure.

Hereby, Phonak Communications AG, Laenggasse 17, CH-3280 Murten, declares that these products are in compliance with the essential requirements and other relevant provisions of Directive (2014/53/EU). To obtain a copy of the Declaration of conformity, please contact the manufacturer or the local Phonak Communications AG representative whose address can be taken from the list on [www.phonak-communications.com/](http://www.phonak-communications.com/) (worldwide locations).

This device complies with Part 15 of the FCC Rules and with (RSS-247 and RSS-210) of Industry Canada.

Operation is subject to the following two conditions: (1) This device may not cause harmful interference, and (2)



---

this device must accept any interference received, including interference that may cause undesired operation. The device has been tested and found to comply with the limits for a Class B digital device, pursuant to Part 15 of the FCC Rules. These limits are designed to provide reasonable protection against harmful interference in a residential installation. The device generates uses and can radiate radio frequency energy and, if not installed and used in accordance with the instructions, may cause harmful interference to radio communications. However, there is no guarantee that interference will not occur in a particular installation. If the device does cause harmful interference to radio or television reception, which can be determined by turning the device off and on, the user is encouraged to try to correct the interference by one of the following measures:

- Reorient or relocate the receiving antenna.
- Increase the separation between the device and receiver.
- Connect the device into an outlet on a circuit different from that to which the receiver is connected.
- Consult the dealer or an experienced radio/TV technician for help.

---

**FCC Caution: Any changes or modifications not expressly approved by the party responsible for compliance could void the user's authority to operate the device.** To comply with FCC RF exposure limits for general population/uncontrolled exposure, the antenna(s) used for this transmitter must be installed to provide a separation distance of at least 20 cm from all persons and must not be collocated or operating in conjunction with any other antenna or transmitter.

This Class B digital apparatus complies with Canadian ICES-003. To comply with Industry Canada RF exposure limits for general population / uncontrolled exposure, the antenna(s) used for this transmitter must be installed to provide a separation distance of at least 20 cm from all persons and must not be collocated or operating in conjunction with any other antenna or transmitter.

### **Japanese Radio Law and Japanese Telecommunications Business Law compliance**

This device is granted pursuant to the Japanese Radio Law (電波法). This device should not be modified (otherwise the granted designation number will become invalid).

---

# 11 Service and warranty

## 11.1 Local warranty

Please ask the local Phonak Communications AG representative where you purchased your device about the terms of the local warranty.

## 11.2 International warranty

Phonak Communications AG offers a 2 (two) years limited international warranty, valid as of the date of purchase. This limited warranty covers manufacturing and material defects. The warranty is valid only if proof of purchase is shown.

## 11.3 Warranty limitation

This warranty does not cover damage from improper handling or care, exposure to chemicals, immersion in water or undue stress. Damage caused by third parties or non-authorized service centers renders the warranty null and void.

---

Serial number:

---

Purchase date:

---

Local Phonak Communications AG representative:

---

---

## 12 Information and explanation of symbols

---



The CE symbol is confirmation by Phonak Communications AG that this product is in compliance with the essential requirements and other relevant provisions of Directive (2014/53/EU).

---



Federal communications commission EMC and Radiocommunications compliance label.

---



Australian and New Zealand EMC and Radiocommunications compliance label.

---



This symbol on the product or its packaging means that it should not be disposed of with your other household waste. It is your responsibility to dispose of your waste equipment separately from the municipal waste stream. The correct disposal of your old appliance will help prevent potential negative consequences for the environment and human health.

---



Important information for handling and product safety.

---



Please read the information on the following pages before using your Phonak Communications AG device.

---



This symbol indicates that it is important for the user to pay attention to the relevant warning notices in these user guides.

---



Temperature transport and storage.

---



Humidity transport and storage.

---



Keep dry.

---

---

## 13 Homologation references

### **Roger BaseStation**

FCC ID: KWCDMBASE

IC: 2262A-DMBASE

**Manufacturer:**

Phonak Communications AG  
Laenggasse 17  
CH-3280 Murten  
Switzerland

[www.phonak-communications.com](http://www.phonak-communications.com)

